

Name:

Datum:

Mathe



# Rechnen bis 10

6	
6	
5	
3	
1	
2	

10	
	10
	3
	6
	4
	8

8	
7	
	2
8	
	7
5	

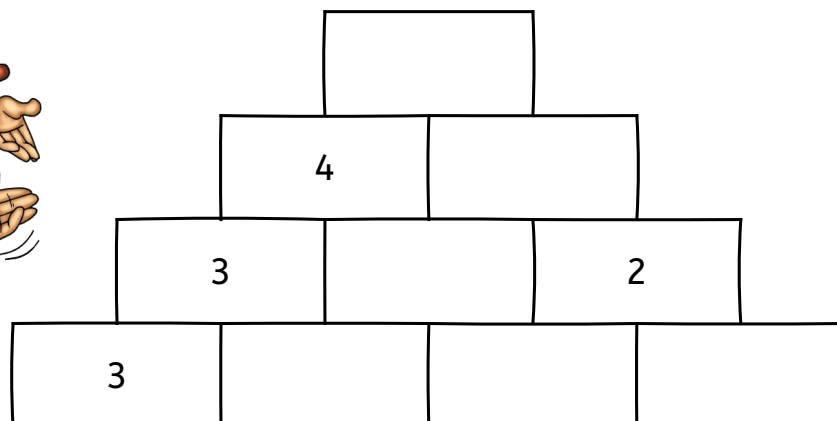
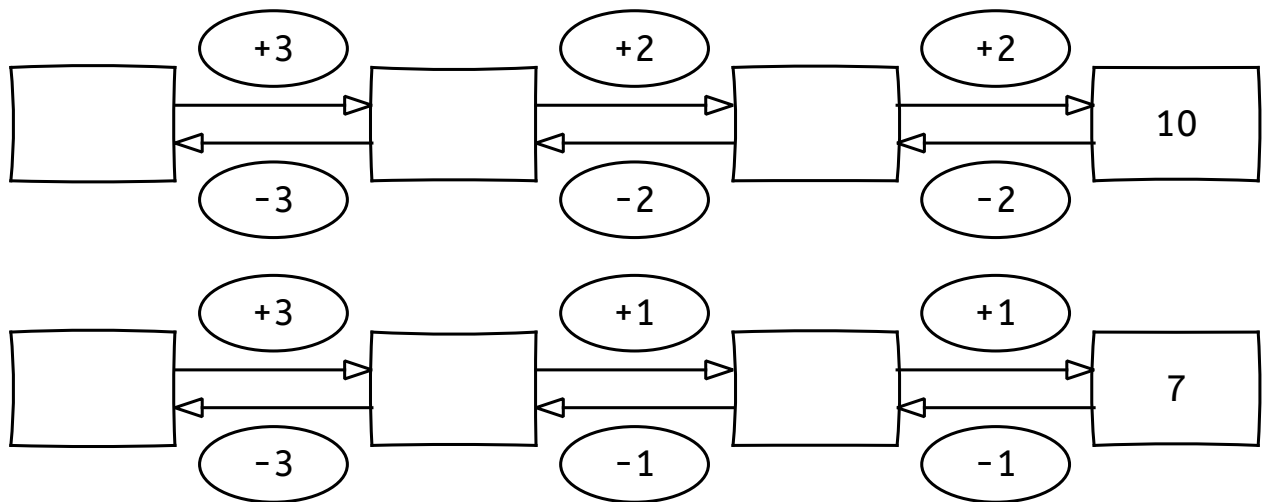

Name:

Datum:

Mathe



# Rechnen bis 10

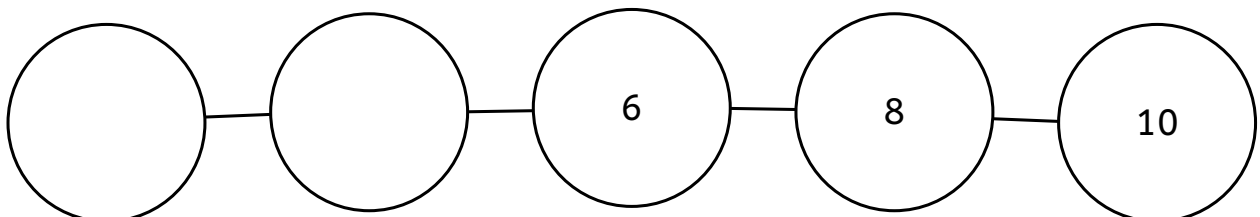
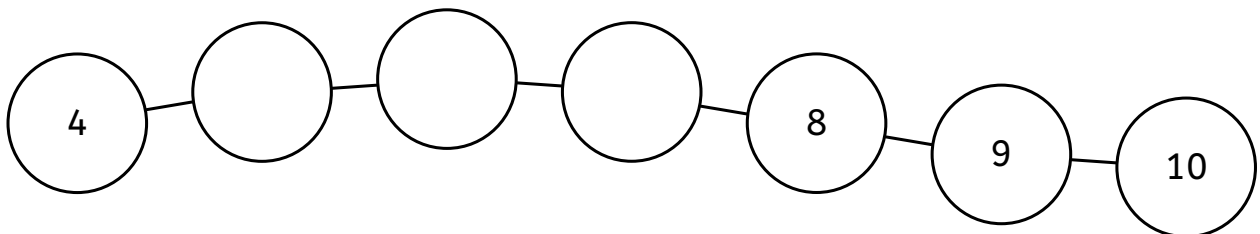
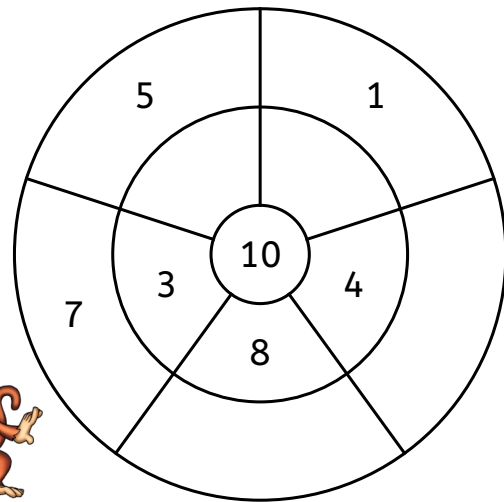
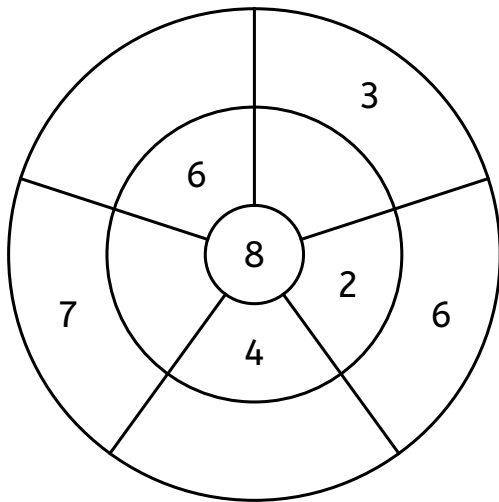
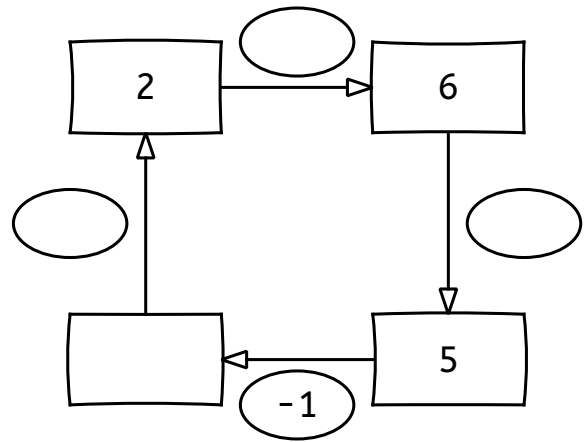
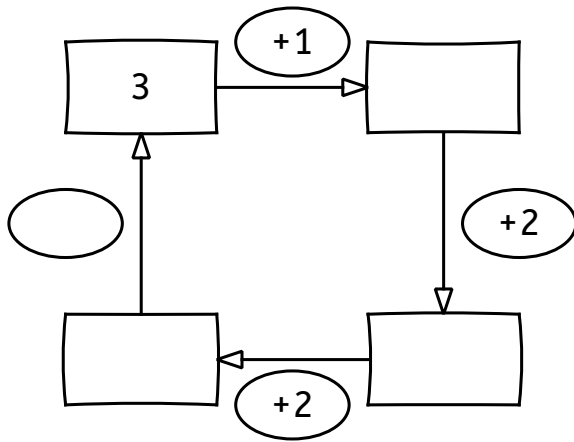



Name:

Datum:

Mathe



# Rechnen bis 10

6	
6	0
5	1
3	3
1	5
2	4

10	
0	10
7	3
4	6
6	4
2	8

8	
7	1
6	2
8	0
1	7
5	3

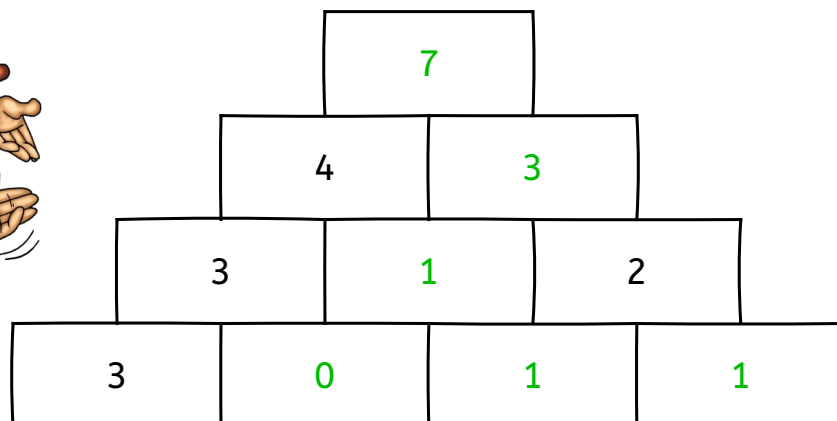
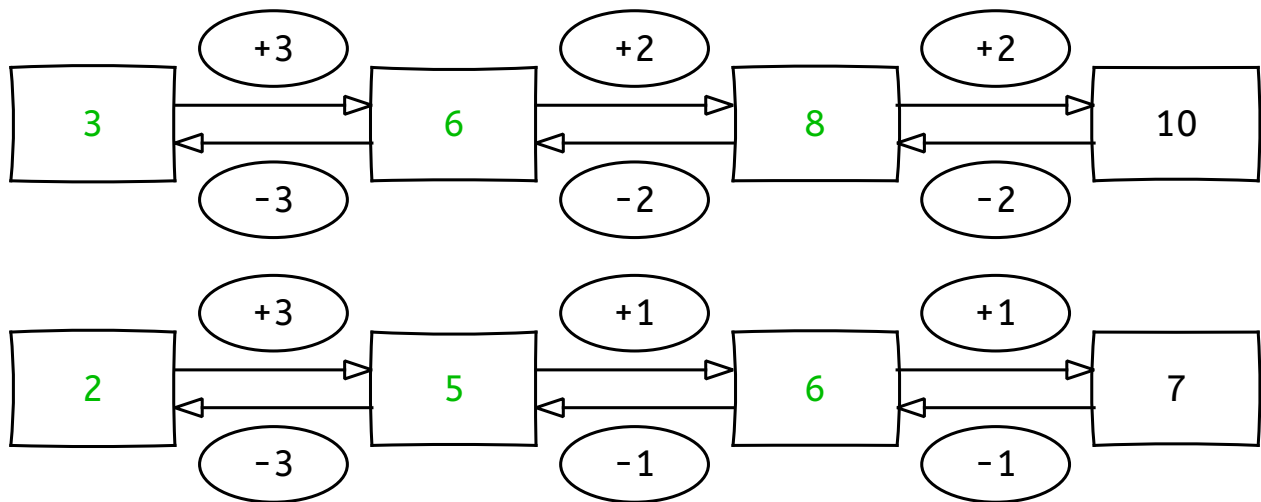

Name:

Datum:

Mathe



# Rechnen bis 10

