

Name:

Datum:

Mathe



# Rechnen bis 20

18	
18	
17	
7	
15	
10	

11	
	1
	8
	6
	11
	0

15	
4	
	12
2	
	9
10	

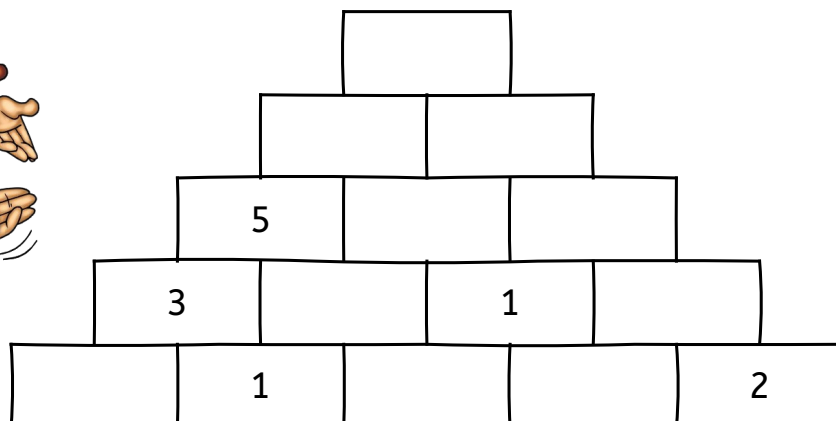
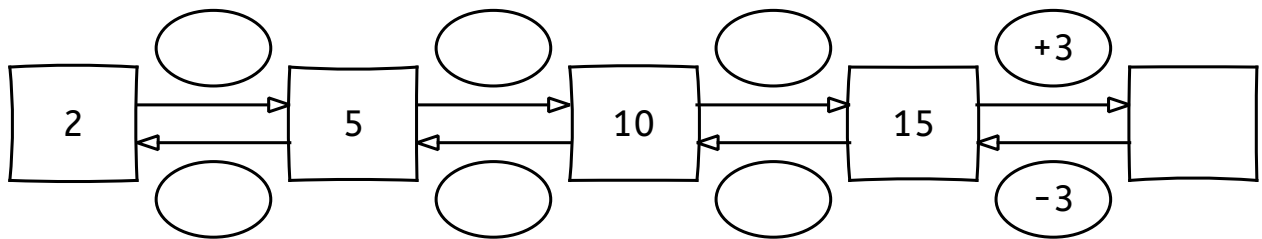
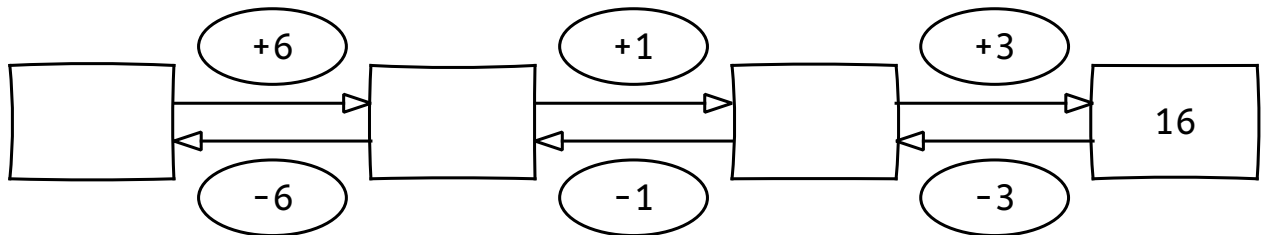

Name:

Datum:

Mathe



# Rechnen bis 20

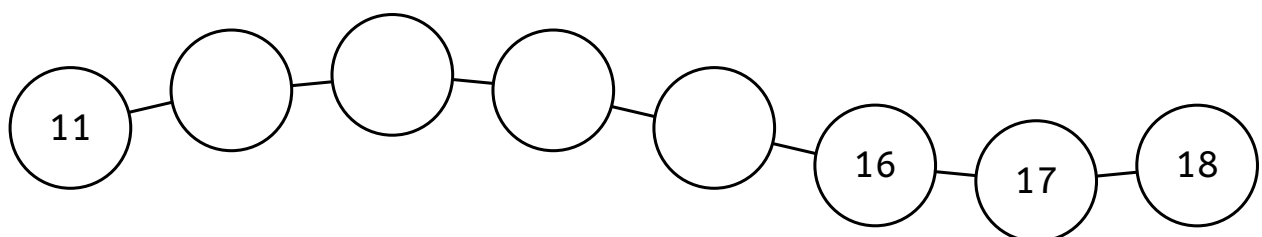
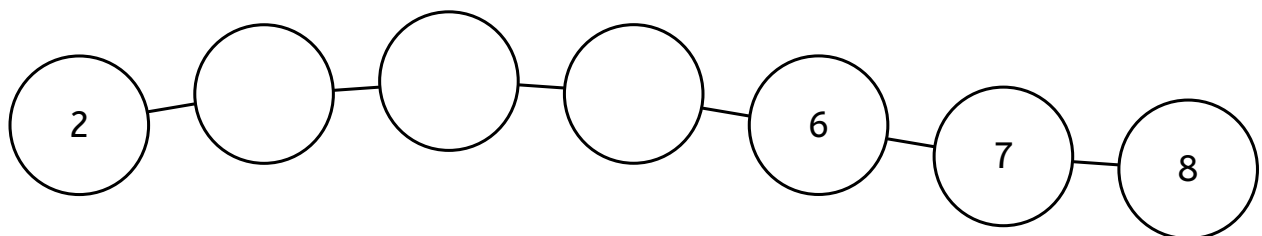
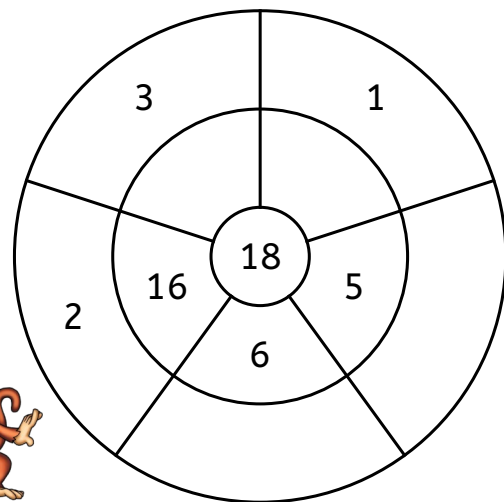
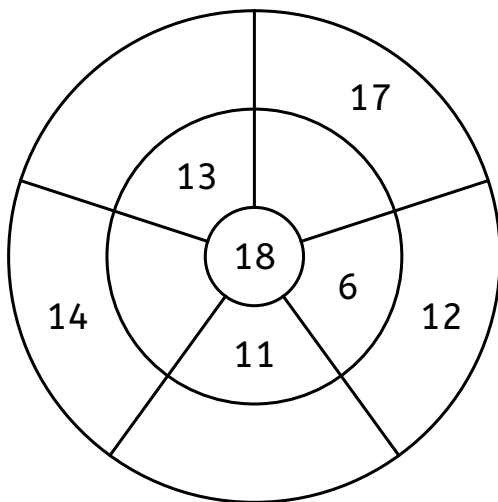
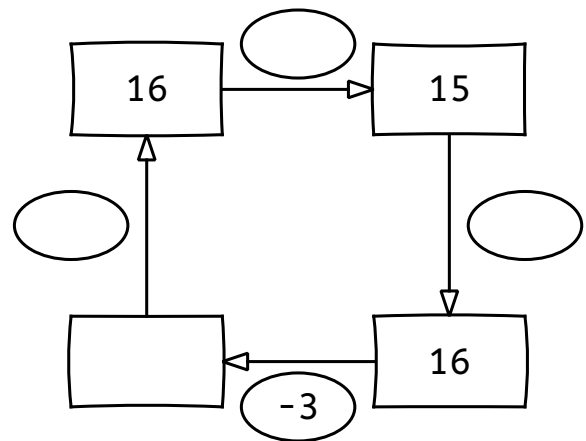
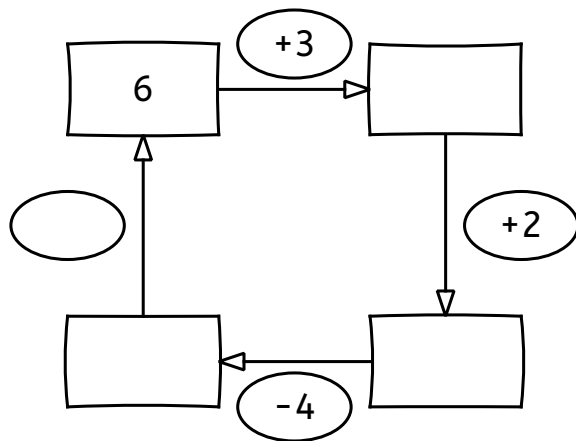

Name:

Datum:

Mathe



# Rechnen bis 20

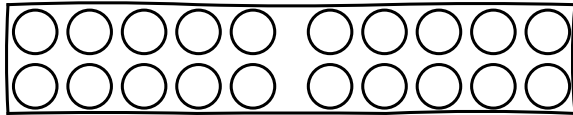

$2 + 17 = \underline{\quad}$

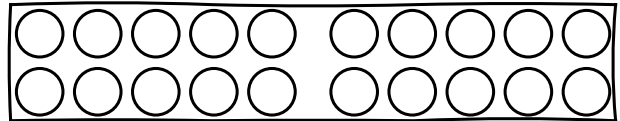

$14 - 10 = \underline{\quad}$

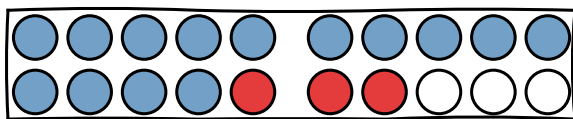

$\underline{\quad} + \underline{\quad} = \underline{\quad}$

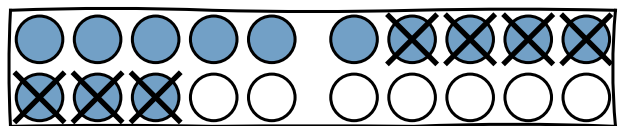

$\underline{\quad} - \underline{\quad} = \underline{\quad}$

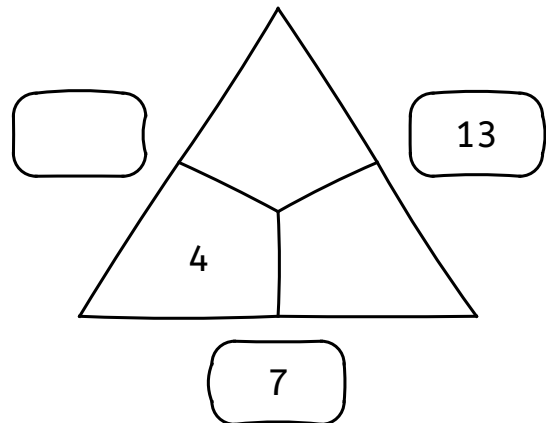
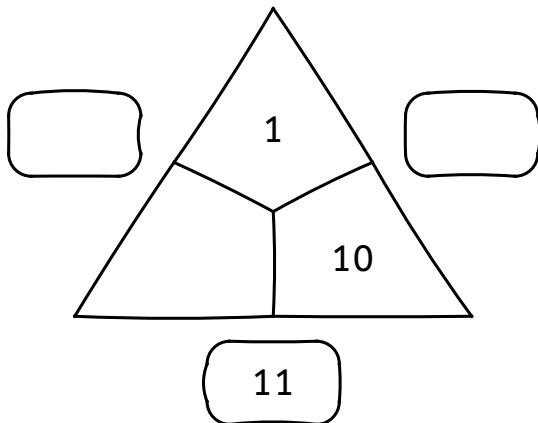

Welche Zahl wird zu 13, wenn man 4 davon abzieht?

Rechnung:

1	3	+	4	=															
---	---	---	---	---	--	--	--	--	--	--	--	--	--	--	--	--	--	--	--

Antwort: Die gesuchte Zahl lautet \_\_\_\_\_.

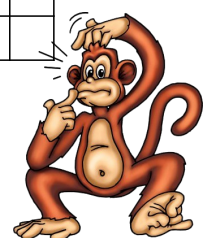

Name:

Datum:

Mathe



# Rechnen bis 20

18	
18	0
17	1
7	11
15	3
10	8

11	
10	1
3	8
5	6
0	11
11	0

15	
4	11
3	12
2	13
6	9
10	5

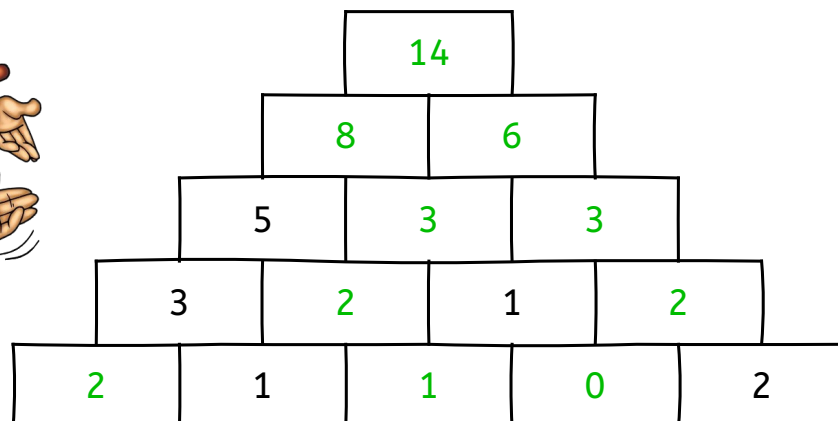
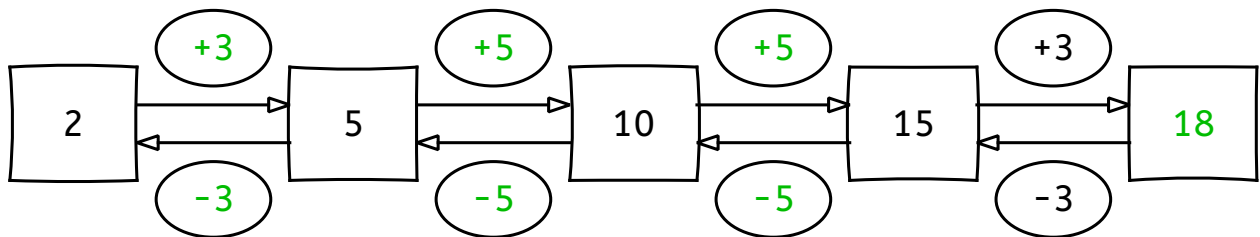
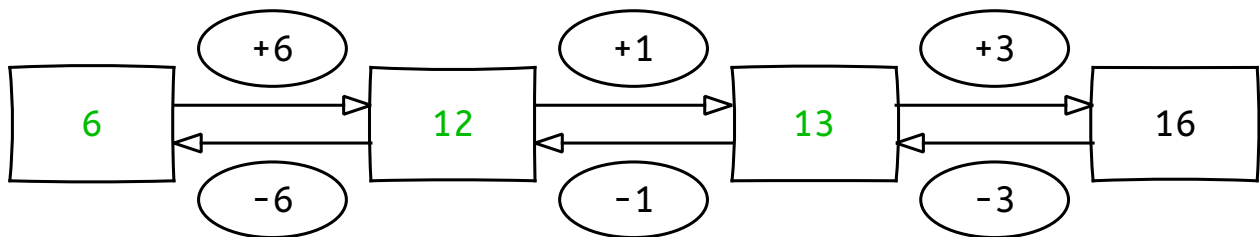

Name:

Datum:

Mathe



# Rechnen bis 20

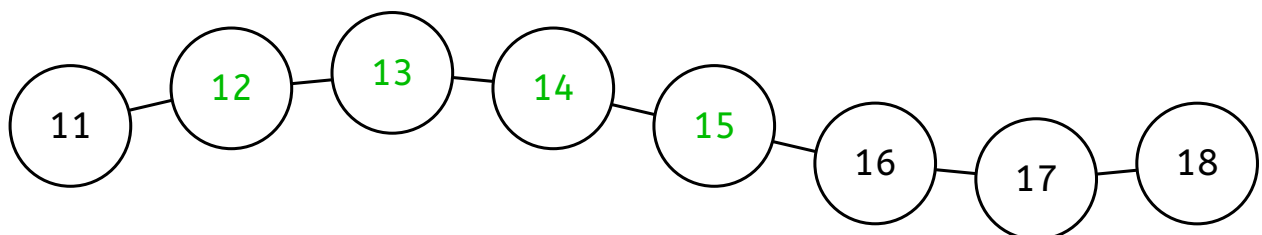
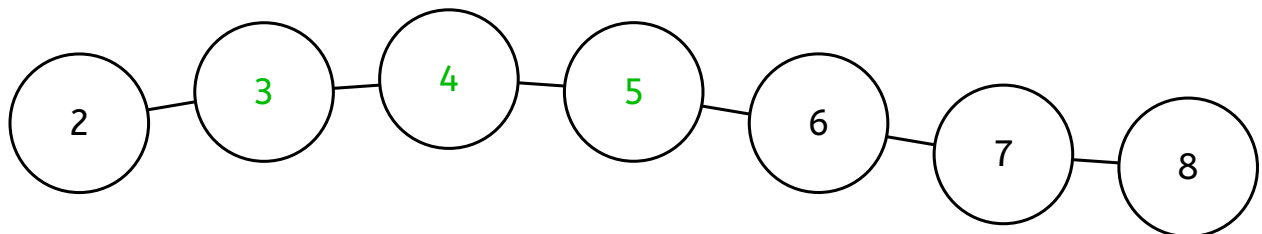
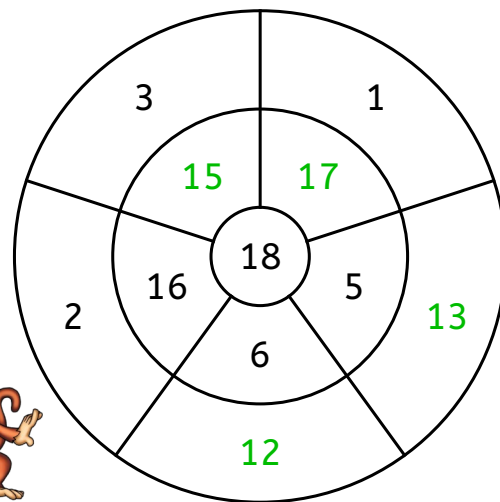
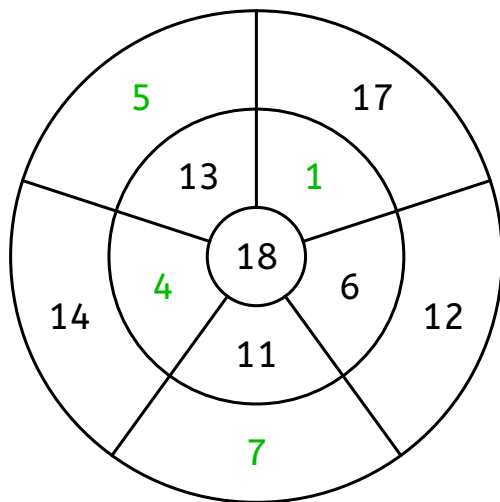
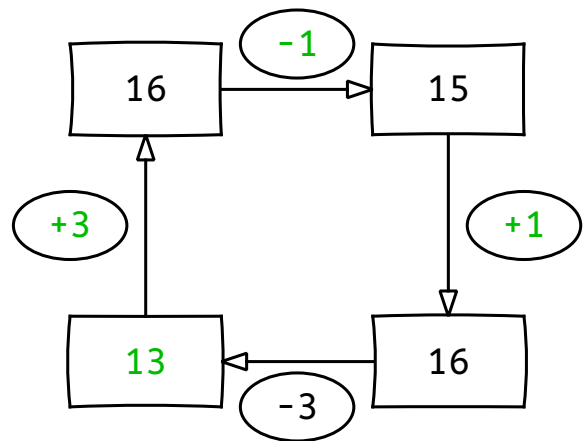
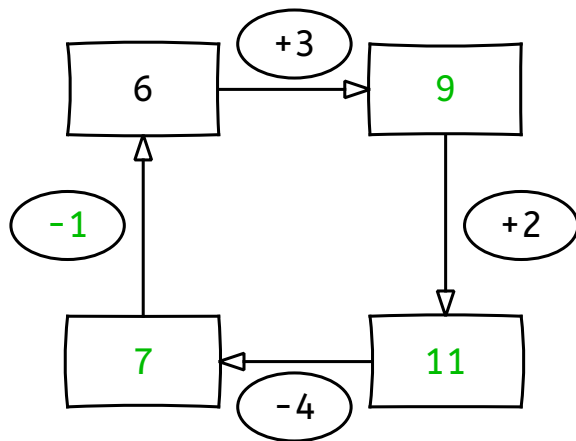

Name:

Datum:

Mathe



# Rechnen bis 20

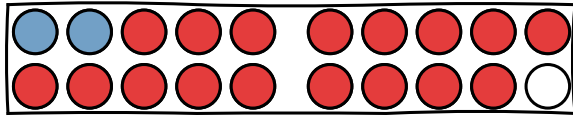

$2 + 17 = 19$

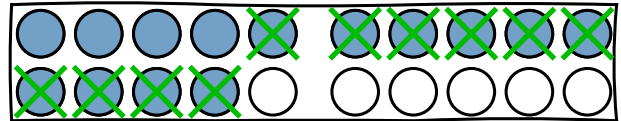

$14 - 10 = 4$

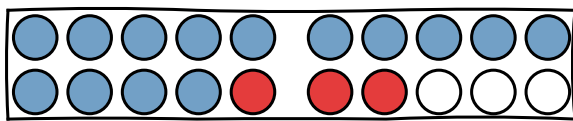

$14 + 3 = 17$

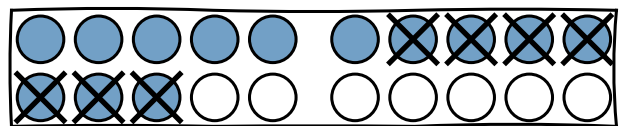

$13 - 7 = 6$

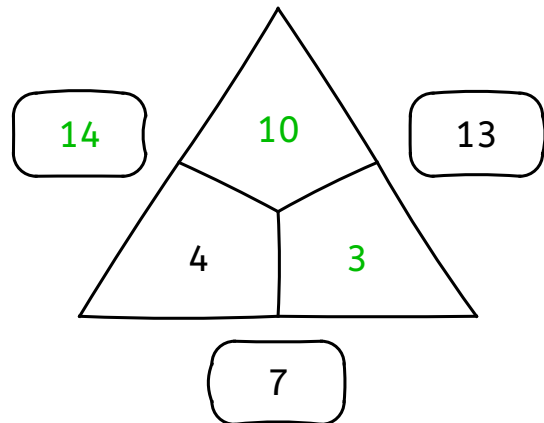
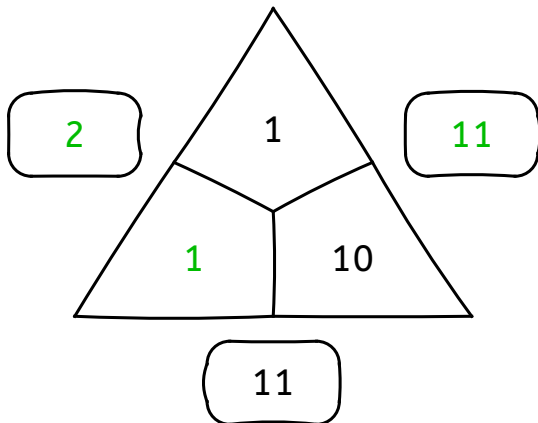

Welche Zahl wird zu 13, wenn man 4 davon abzieht?

Rechnung:

1	3	+	4	=	1	7													

Antwort: Die gesuchte Zahl lautet 17 .

